

NDS26 Cat. 6 Data Outlet



**20
YEAR
GUARANTEE**

A new take on traditional moulded wiring accessories manufactured in bright white Urea.

Technical Drawing

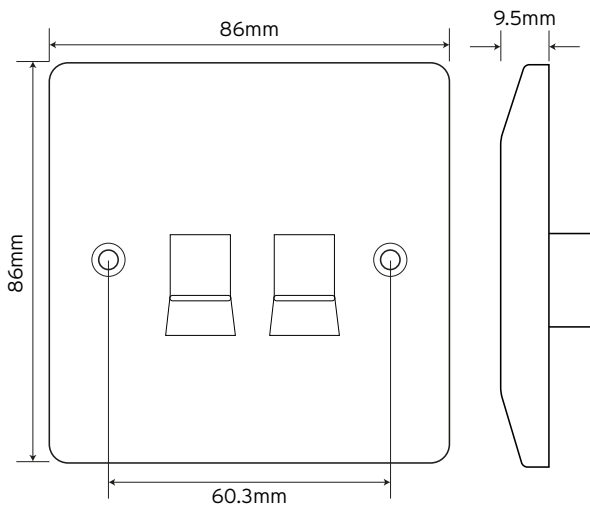

Technical Specifications

Type	2 x Cat. 6 Data Outlet
Material Composition	Front Plate: Urea
Backbox Depth	35mm
Warranty	20 Years
Anti Microbial Certified	Yes
IP Rating	IP20
Operational Temperature	-5° to +40° C
Standards	The Low Voltage Directive 2006/95/EC BS 6312-2-2:1997 (where applicable) BS EN 50173-1:2011 (where applicable) BS 5733:1995 (where applicable) Modified ISO 22196
Dimensions	86x86x9.5mm (HxWxD)